



Digi-Mantle – A Reaction Station with Interchangeable Mantles.

OMCA0250, OMCA0500, OMCA1000.

INSTRUCTION BOOK.

Please take your time to read this Instructions book in order to understand the safe and correct use of your new Bibby Scientific product.

It is recommended the Responsible Body for use of this equipment reads this Instruction book and ensures the user(s) are suitably trained in its operation.

Contents.

Section 1.	Introduction	Page 3
Section 2.	Symbols and using this instruction book.	Page 4
Section 3.	Safety Information.	Page 5
Section 4.	Unpack and Contents.	Page 7
Section 5.	Installation.	Page 8
Section 6.	Environmental Protection.	Page 9
Section 7.	Product Operation.	Page 10
Section 8.	Technical Specification.	Page 21
Section 9.	Maintenance	Page 23
Section 10.	Parts and Accessories	Page 25
Section 11.	Customer Support	Page 26
Section 12.	EC Declaration of Conformity.	Page 28
Appendix 'A'	Decontamination Certificate	Page 27

© The copyright of this instruction book is the property of Bibby Scientific Limited. This instruction book is supplied by Bibby Scientific Limited on the express understanding that it is to be used solely for the purpose for which it is supplied. It may not be copied, used or disclosed to others in whole or part for any purpose except as authorised in writing by Bibby Scientific Limited. Bibby Scientific Limited reserves the right to alter, change or modify this document without prior notification.

In the interest of continued development Bibby Scientific Limited reserve the right to alter or modify the design and /or assembly process of their products without prior notification.

This product is manufactured in Great Britain by Electrothermal, part of the Bibby Scientific Group of companies.

Bibby Scientific Limited.
Beacon Road,
Stone,
Staffordshire ST15 0SA,
Great Britain.

Tel: +44(0)1785 812121
Fax: +44(0)1785 810405

1. INTRODUCTION

- 1.1. Your Digi-Mantle has been designed to provide a comprehensive answer to heating and stirring fluids in various vessel formats. This product is modular in design allowing for complete interchange ability between mantles of various sizes. With its 'easy to read / easy to operate' revolutionary CTC (Capacitance Touch Control) panel, setting the required temperature and stir speed takes only seconds.
- 1.2. Heating is controlled by a modern 'state of the art' micro processor, which displays the heat setting as a percentage of the total power. When the temperature probe is fitted, the heating is controlled via the temperature feed back circuit and the actual temperature is displayed. All new dry blocks come with an inbuilt temperature sensor. This allows the true block temperature to be viewed at all times. When using a probe and dry block with in built sensor, the temperature displayed is that as measured by the probe.
- 1.3. An 'all new' digital controller and motor arrangement allow for accurate, low speed stirring control. Uniform stirring is provided via a motorised rotating magnet assembly positioned to provide maximum magnetic flux linkage to rotate the stirrer bars in each reaction vessel.

2. SYMBOLS AND USING THIS INSTRUCTION BOOK.

2.1. Throughout this Instruction book the following symbols are shown to identify conditions which pose a hazard to the user, or to identify actions that should be observed. These symbols are also shown on the product, or its packaging. When a symbol is shown next to a paragraph or statement it is recommended the user takes particular note of that instruction in order to prevent damage to the equipment or to prevent injury to one's self or other people.

To prevent injury or equipment damage it is the manufacturer's recommendation that all persons using this equipment are suitably trained before use.

2.2. Symbols Defined.



Caution, risk of danger. See note or adjacent symbol.



Protective conductor terminal to be earthed.
Do Not loosen or disconnect.



Caution / risk of electric shock



Recyclable Packing Material



Do not dispose of product in normal domestic waste.



Caution. Hot surface.

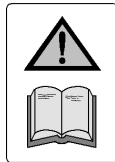

Refer to Operator Instructions book.



Stirring Facility On / Off



Heating Facility On / Off



Bio Chemical Hazard. Caution required. Will require decontamination.

3. SAFETY INFORMATION.

This product has been designed for safe operation when used as detailed in accordance with the Manufactures instructions.

NOTE: Failure to use this equipment in accordance with the manufactures operating instructions may compromise your basic safety protection afforded by the equipment and may invalidate the warranty / guarantee. The warranty / guarantee dose not cover damaged caused by faulty installation or misuse of the equipment.

3.1. Prevention of Fire and Electric Shock.



To prevent a risk of fire or electric shock, **DO NOT** open your product case without authorisation. Only qualified Service personnel should attempt to repair this product



Replace fuses only with the type as listed in section, Parts and Accessories (See fuse type and rating)



Ensure the Mains Power Supply conforms to rating found on the data plate located on the underside of each item of this equipment.



Never Operate this equipment with out connection to earth / ground. Ensure the mains supply voltage is correctly earthed / grounded in accordance with current area legislation.

3.2. General Safe Operating Practice.



Always follow good laboratory practice when using this equipment. Give due recognition to your company's safety and legislative health & safety procedures and all associated legislation applicable to your areas of operation. Check laboratory procedures for substances being heated and ensure all hazards (e.g. explosion, implosion or the release of toxic or flammable gases) that might arise have been suitably addressed before proceeding. When heating certain substances the liberation of hazardous gases may require the use of a fume cupboard or other means of extraction.



Ensure equipment is used on a clean, dry, non-combustible, solid work surface with at least 300mm suitable clearance all around from other equipment.



Do not position the product so that it is difficult to disconnect from the mains supply.



Do not touch the heating element or any glass vessel whilst in use.



Do not immerse unit in water or fluids.



Do not spill substances onto the mantle. If spillage does occur, disconnect unit from mains supply and follow instructions as detailed in Section 'Maintenance'.



Do not cover the mantle whilst in use.



Do not leave equipment switched on without a charged flask(s).



Do not install or remove the mantle from the control unit whilst power is applied to the controller.



Do not thermally insulate the exposed upper section of the vessel(s), as the insulation used may obstruct the convection cooling airways around the rim of the cartridge enclosure and cause the mantle to overheat.



It is not recommended to leave any heating apparatus unattended during operation.



Only use Original Equipment manufactures spares and accessories. Ref Section 10.



This equipment employs the use of rotating magnets. Keep all metal objects and magnetic data devises (credit cards, door / security passes) away from the stirrer unit.



The equipment is not spark, flame or explosion proof and has not been designed for use in hazardous areas in terms of BSEN 60079-14:1997. Keep flammable, low flash point substances away from the apparatus.



Do not operate or handle any part of this product with wet hands.



Keep the Mains cord and moulded IEC plug and lead set cable away from the heating surface.

4. UNPACK AND CONTENTS.

4.1. OMCA0250, OMCA0250X1, OMCA0500, OMCA0500X1, OMCA1000, OMCA1000X1,

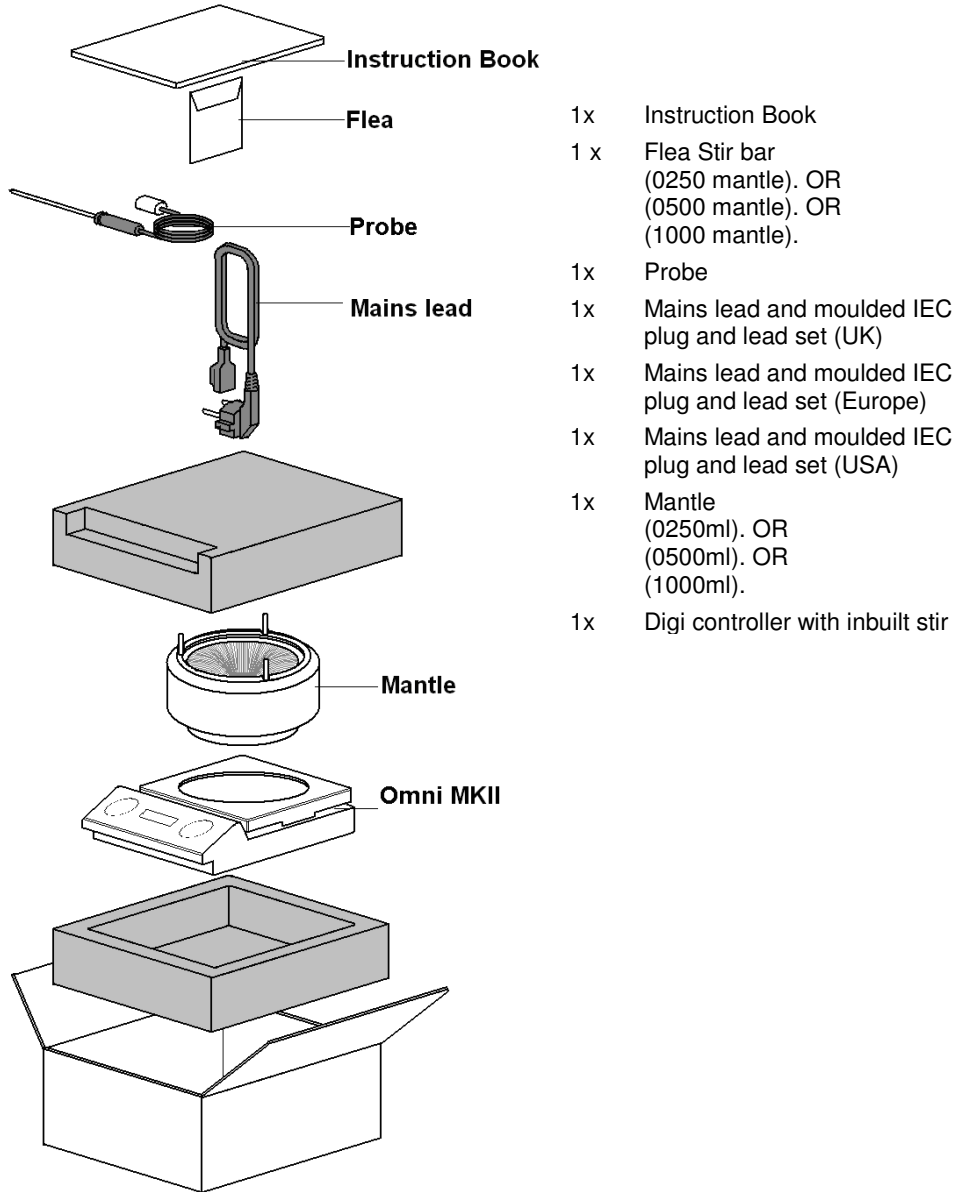

For your future reference please record your products Serial and Model numbers.	<i>Controller Serial Number</i>
	<i>Mantle Serial Number</i>

5. INSTALLATION.

5.1. Electrical safety and installation.

5.1.1. This equipment is designed for safe use under the following conditions:-

- Indoor use.
- Altitude up to 2000 meters.
- Temperatures between 5°C and 40°C.
- Maximum relative humidity 80% for temperatures up to 31°C decreasing linearly to 50% relative humidity at 40°C.
- Mains input supply voltage fluctuations up to $\pm 10\%$ of the nominal voltage.
- Transient over-voltages typically present on the mains supply.
- Applicable rated pollution degree 2.

5.1.2.  This equipment must be earthed / grounded to a fixed earth / grounded mains socket outlet. The mains supply is to be earthed / grounded in accordance with current legislation.

5.1.3. Ensure only the correct rated mains input fuses are fitted. (Where applicable ensure the correct Mains cord and moulded IEC plug and lead set cable fuse if fitted). See Technical Information Section 8 of this document.

5.1.4. Check the input voltage on the product data label of each Digi-Mantle item. Ensure the rating conforms to your local supply.

5.1.5. This product should be connected to a mains supply source which incorporates an RCD or GFCI device that has a tripping current of 30mA or less. The RCD or GFCI residual Current Device cuts off power to the equipment immediately it detects a current leakage fault. For example, cutting off the power when there is an accidental liquid spillage in a mantle protected with an earth (ground) screen.

5.1.6. The unit is supplied with a Mains cord and moulded plug set cable wired as follows.

 **Green / Yellow** or **Green** = **Earth / Ground**
Blue or **White** = **Neutral**
Brown or **Black** = **Live / line hot.**

When using with a new mantle:

Observation: the surface of the heating element of a mantle cartridge will upon receipt look slightly discoloured. This discolouration is normal and occurs at the factory during testing when the mantle is first heated up.

6. ENVIRONMENTAL PROTECTION.

- 6.1. Maximum consideration has been given to environmental issues within the design and manufacturing process without compromising end product performance and value.



- 6.2. Packaging materials have been selected such that they may be sorted for recycling.



- 6.3. At the end of your product and accessories life, it must not be discarded as domestic waste. Ref: EU Directive 2002/96/EC on Waste Electrical and Electronic Equipment Directive (WEEE). Please contact your distributor / supplier for further information. For end users outside of the EU consult applicable regulations.

- 6.4. This product should only be dismantled for recycling by an authorised recycling company.



This product and accessories must be accompanied by a completed Decontamination Certificate prior to any disposal. Copies of the Certificate are available from your distributor of Bibby Scientific products, or you may copy and enlarge from 'Appendix A' of this instruction book.

Bibby Scientific's Electrothermal branded product range is registered with the Environment Agency under the name of as Electrothermal Engineering Limited as being a producer of WEEE (Waste Electronic and Electrical Equipment) through b2b Compliance, an authorised waste collection compliance scheme.

7. PRODUCT OPERATION.

7.1. Overview.

Your Digi-Mantle has been designed for easy operation. The illustrations show a detailed layout of your Digi-Mantle control unit.

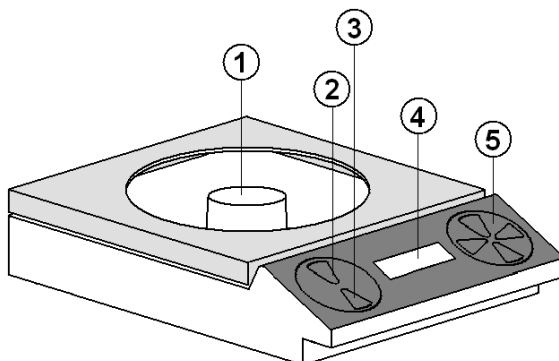

Figure 7 - 1

- 1 Magnetic Stir Hub.
- 2 Stir activation key
- 3 Heater activation key
- 4 LCD Display
- 5 Menu selection keys

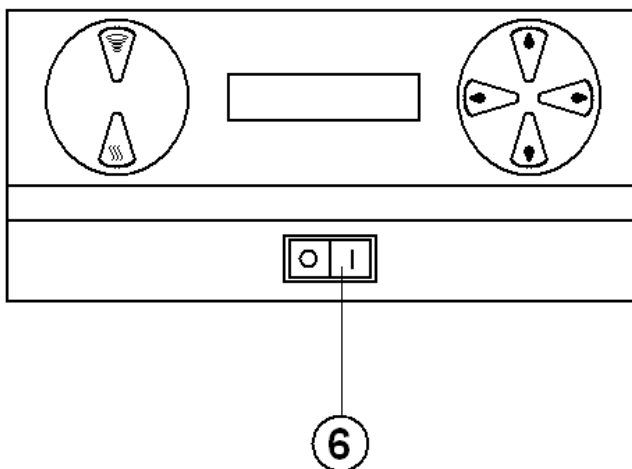

Figure 7 - 2

- 6 On / Off power switch

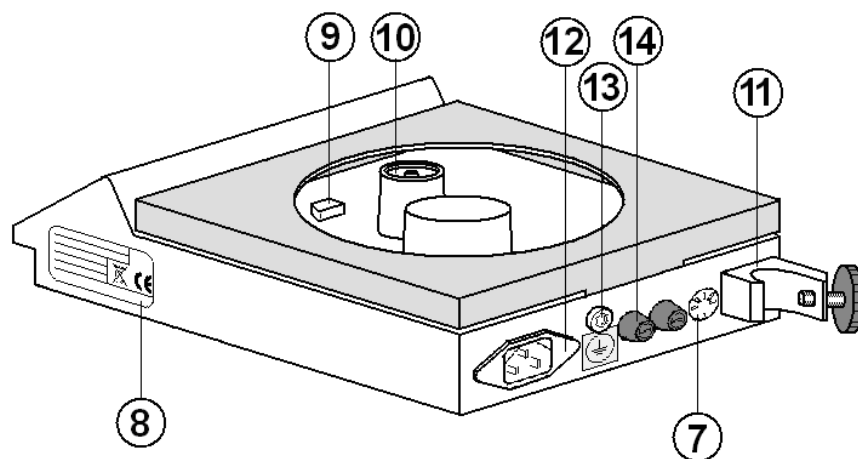

Figure 7 - 3

- 7 External probe socket.
- 8 Data plate label.
- 9 Mantle cartridge control plug
- 10 Mantle cartridge power supply socket
- 11 Vertical Rod clamp fastening bracket
- 12 Mains Input IEC socket.
- 13 Earth test point
- 14 Fuses.

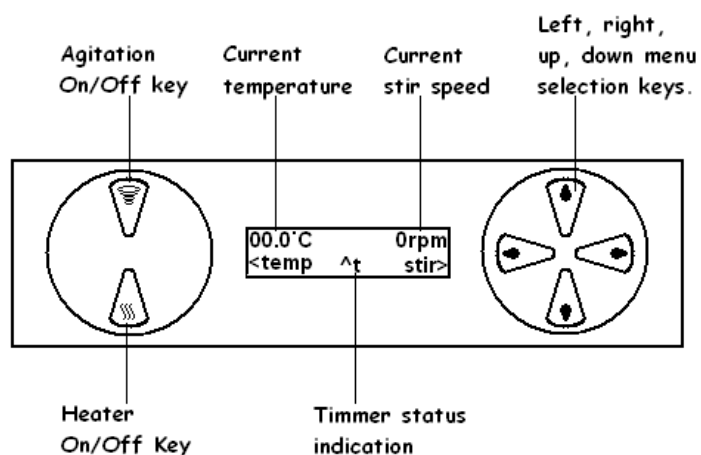

Figure 7 - 4
Typical front screen display.

7.2. Support Rod. (optional).

The Digi-Mantle incorporates a vertical rod support bracket. The rod is to be fastened into the bracket. Glass arrangements are to be secured in conjunction with appropriate clamp and flask support when using a Mantle.

7.3. Fitting a Mantle

- 7.3.1. Fitting a Mantle cartridge is achieved by aligning the 9 pin plug of the Mantle cartridge with the 9 pin socket.

7.3.2. Carefully lower the Mantle cartridge into the control unit ensuring the tabs on the controller align with the grooves in the base of the dry block or mantel ensuring positive engagement.

7.3.3. If required, insert the external sample temperature probe plug into the external probe socket.



WARNING.

Care should be exercised when handling a Mantle.



WARNING.

Ensure the mains electricity supply is turned off and disconnected before fitting a Mantle.

7.4. Power on and Front Screen menu.

7.4.1. Connect the Mains cord and moulded IEC plug and lead set cable supplied with the Digi-Mantle into the mains power inlet socket (see figure 7-3, item12). Press the On / Off switch (see figure 7-2 item 6) to the on position.

7.4.2. The LCD display will go through a warm and self check routine that will take a few seconds during which the Digi-Mantle Software revision will be displayed for 5 seconds before conformation. Upon completion of the routine the Digi-Mantle LCD will then display the type of heating apparatus being used. (See figure 7-4).

Note: All function selections and settings are made using the menu keys. The keys are indicated using $\langle \wedge \rangle$ symbols in the LCD display.

Press the right hand menu key \rangle to confirm correct module.



Figure 7-5

Note: The profile for 500ml is the same as the 1000ml. When using the 500ml mantle 1000ml will be shown on the display. Please note this is not a fault of the unit or the mantle. The 250ml mantle will display 250ml Mantle.

If the Error message '**Module Missing**' is displayed (see figure 7-6) turn off the Digi-Mantle unit. Insert a Mantle cartridge or ensure the existing module is correctly seated.



Figure 7-6

• the main screen menu will look like the illustration seen in Figure 7-7.

Note: The **e** character next to the temperature display when external probe is connected.



Figure 7-7.

7.5. Stir speed setting and activation.

From the main display screen menu press the > key to enter the 'Stir speed' setting screen. (See figure 7-8).

Note: the Stir speed displayed is that of the last setting made by the user.



Figure 7-8.

Press the > key to enter the stir speed selection screen. (See figure 7-9).



Figure 7-9.

Press the ^ key to make the 100's value selection. Press the V key if you wish to reduce the selected stir speed value.

Press the > key to go into the 10's selection screen (See figure 7-10).



Figure 7-10.

Press the ^ key to make the 10's value selection. Press the V key if you wish to reduce the selected stir speed value.

Press the > key to return to the front screen menu.

OR.....

If 10 seconds elapse without a key being pressed the display is to return to the main display menu.

Note: There is no facility for setting the units stir speed value.

To start the stirring process press the stir key marked with the symbol 

To stop the stirring process press the stir key once more.

Note. To show stirring is in operation the stir symbol will remain illuminated. The stir speed shown on the LCD is the true speed of stir. Not the setting.

7.6. Heat setting and activation.

7.6.1. Setting the temperature when using a Mantle cartridge without internal sensor.

From the main display menu screen press the < key to go into the 'Heat setting' screen. (See figure 7-11).

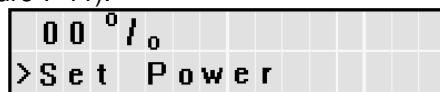

Figure 7-11.

Note: The default setting will always display 00%. Previous power settings are not retained.

Press the > key to go into set power selection screen. (See figure 6-12).

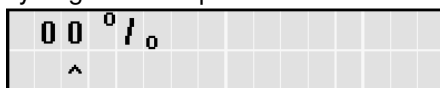

Figure 7-12.

Press the ^ key to make the % power selection. Press the V key if you wish to reduce the power selection.

Note: The power settings are made in increments of 5°C. The power selection range is from 0 to 100%.

Press the > key to return to the front screen menu.

OR.....

If 10 seconds elapse without a key being pressed the display is to return to the main display menu.

To start the heating process press the heating key marked with the symbol .

To stop the heating process, press the heating key once more.

Note. To show heating is in operation the heat symbol will remain illuminated. The power percentage shown on the LCD is that of the setting.

7.6.2. Setting the temperature when using Mantle cartridge using the external probe.

Note: With the external probe attached an e symbol will appear in the LCD next to the temperature reading indicating the connection of the external probe (See Figure 7-9). The Temperature reading displayed is that read by the probe.

The external probe is to be placed in the sample solution. Heating your sample is now controlled via the external probe.

From the main display menu screen press the < key to go into the 'Temperature setting' screen. (See figure 7-13).

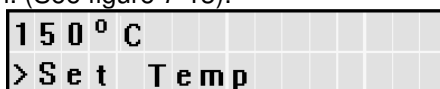

Figure 7-13.

Note: the Stir temperature displayed is that of the last setting made by the user.

Press the > key to go into temperature selection screen. (See figure 7-14).

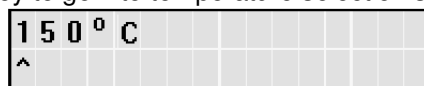

Figure 7-14.

Press the ^ key to make the 100's temperature value selection. Press the V key if you wish to reduce the selected temperature value.

Press the > key to go into the 10's temperature selection screen (See figure 7-15).

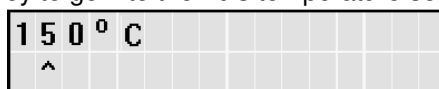

Figure 7-15.

Press the ^ key to make the 10's temperature value selection. Press the V key if you wish to reduce the selected temperature value.

Press the > key to go into the units temperature selection screen (See figure 7-16).

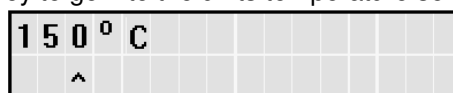

Figure 7-16.

Press the ^ key to make the units temperature value selection. Press the V key if you wish to reduce the selected temperature value.

Press the > key to return to the front screen menu.

OR.....

If 10 seconds elapse without a key being pressed the display is to return to the main display menu.

To start the heating process press the heating key marked with the symbol SSS .

To stop the heating process press the heating key once more.

Note: To show heating is in operation the heat symbol will remain illuminated. The actual temperature shown on the LCD is that seen by the internal dry block sensor.

Note: During the heat up process the SSS will flash to indicate the set temperature has not been reached. Once the set temperature has been reached the flashing symbol will remain constantly illuminated. To accommodate over / under temperature oscillation the symbol will not recommence flashing until the temperature is $\pm 5^{\circ}\text{C}$ off of the set temperature.

Note: (When used with external probe) the temperature range setting for a ambient $+5^{\circ}\text{C}$ to 220°C settable in increments of 1°C

7.7. Timer Operation.

Your Digi-Mantle has the facility to set a countdown timer which will switch off the heaters after a per-set time period. The timer can be set for up to 99hours 59 minutes.

Set the required heating temperature as described in section 7.6.

From the main display screen press the **^** key to enter 'time set' mode. (See figure 7-17).



Figure 7-17.

Press the **^** to make the 10's hours selection. Pressing the **V** will reduce the selection.

Note: Once a time digit has been set all the remaining time set digits will default to zero until they are set.

Press the **>** key to go into the unit hours selection. (See figure 7-18).



Figure 7-18.

Press the **^** to make the unit hours selection. Pressing the **V** will reduce the selection.

Press the **>** key to go into the 10's minutes selection. (See figure 7-19).



Figure 7-19.

Press the **^** to make the 10's minutes selection. Pressing the **V** will reduce the selection.

Press the **>** key to return to the front screen menu.

OR.....

If 10 seconds elapse without a key being pressed the display is to return to the main display menu.

Note: There is no setting facility of setting unit minutes.

To start the heating process press the heating key marked with the symbol **SSS**.

The timer will not commence count down until the heaters are activated.

With the timer set the front screen will display count down hours indicated with an **h** symbol next to the time display. (See figure 7-20).

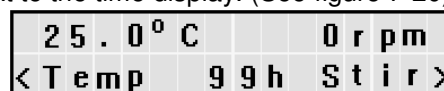





Figure 7-20.

When only minutes remain on the time counter the display will switch over to a minutes count and the **m** symbol will be displayed next to the time display. (See figure 7-21).

25.0° C	0 rpm
<Temp	59m Stir>

Figure 7-21.

When the timer counter reaches zero the heaters are turned off. The  key illumination is extinguished and the main display screen reverts to . A one second 'beep' is sounded when the heaters are turned off in timer mode.

Note: At any time during the use of the timer facility the heaters may be turned off manually using the  key.

7.8. Keypad Lock / Unlock.

To prevent accidental switching of functions or the disturbance of run settings the Digi-Mantle has a 'Keypad lock facility.

7.8.1. To lock the keypad.

Press the down arrow  key. The display will now instruct you to press the left arrow menu key. (See figure 7-22).

To	lock	keYPad
Press	<	

Figure 7-22.

Press the left arrow  key. The display will now instruct you to press the up arrow menu key. (See figure 7-23).

To	lock	keYPad
Press	^	

Figure 7-23.

Press the up arrow  key. The display will now instruct you to press the right arrow menu key. (See figure 7-24).

To	lock	keYPad
Press	>	

Figure 7-24.

Press the right arrow  key. The display will confirm the keypad is locked. (See figure 7-25).

keYPad	lock
--------	------

Figure 7-25.

Note: To lock the keypad you have selected all of the arrow menu keys in a clockwise rotation.

7.8.2. To unlock the keypad.

Press the up arrow \wedge key. The display will now instruct you to press the right arrow menu key. (See figure 7-26).



The LCD display shows two lines of text. The first line reads "To Unlock keypad" and the second line reads "Press <".

Figure 7-26.

Press the right arrow \leftarrow key. The display will now instruct you to press the down arrow menu key. (See figure 7-27).

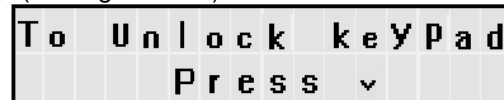

The LCD display shows two lines of text. The first line reads "To Unlock keypad" and the second line reads "Press v".

Figure 7-27.

Press the down arrow ∇ key. The display will now instruct you to press the left arrow menu key. (See figure 7-28).



The LCD display shows two lines of text. The first line reads "To Unlock keypad" and the second line reads "Press >".

Figure 7-28.

Press the left arrow \rightarrow key. The display will return to standard operational mode. (See figure 7-4).

Note: To unlock the keypad you have selected all of the arrow menu keys in an anti-clockwise rotation.

7.9. Errors and Warnings.

7.9.1. Warning – External Probe unplugged during operation.

If during use the external probe becomes detached from the Digi-Mantle the following error message will be displayed (See figure 7-29).

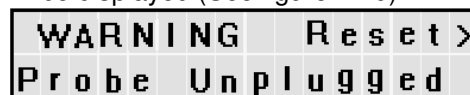

The LCD display shows two lines of text. The first line reads "WARNING Reset >" and the second line reads "Probe Unplugged".

Figure 7-29.

The unit will 'beep' rapidly for 10 seconds.

The heaters will be turned off.

If the unit was stirring a sample it will continue to do so.

The Warning will remain on the LCD until the \rightarrow key is pressed.

The unit will return to the main display screen for use without the external probe unless the connection is re-established. The heaters must then be turned back on manually by pressing the \lll key.

7.9.2. Warning – External probe plugged in but inadvertently left out of the sample.

When an external probe is plugged in and the heaters turned on your Digi-Mantle will expect to see a rise in temperature of no less than 6°C within the first 10 minutes. Should the external probe be accidentally left out of the sample solution the following will be displayed (See Figure 7-30).

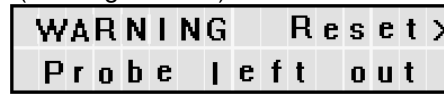

Figure 7-30.

The unit will 'beep' rapidly for 10 seconds.

The heaters will be turned off.

If the unit was stirring a sample it will continue to do so.

The Warning will remain on the LCD until the > key is pressed.

Rectify the fault

The unit will return to the main display screen for use without the external probe unless the connection is re-established. The heaters must then be turned back on manually by pressing the  key.

7.9.3. Warning – Probe has fallen out of the sample

If during the heating cycle the external temperature probe falls out of the sample the following condition will arise (See figure 7-31).



Figure 7-31.

Should the external probe fall of the sample the unit will see a decrease in temperature. Once the probe temperature has dropped more than 6°C in 60 seconds the heaters will be turned off.

The unit will 'beep' rapidly for 10 seconds.

If the unit was stirring a sample it will continue to do so.

The Warning will remain on the LCD until the > key is pressed.

Rectify the fault

The unit will return to the main display screen for use without the external probe unless the connection is re-established. The heaters must then be turned back on manually by pressing the  key.

7.9.4. Warning – Heating module remover during operation.

If a Mantle is removed from the Digi-Mantle when the unit is powered up the Module missing screen will be displayed (see Figure 7-6). Stirring and heating will stop.

This message will disappear when a Mantle is reinstated. The module type will be displayed in the LCD. Press > key to return to the main display screen. Stirring and Heating must then be manually turned back on.

8. TECHNICAL SPECIFICATIONS.

8.1. Specifications.

Mains Input Supply Power.	230V-AC or 115/100V-AC @ 50/60Hz
Fuse rating (115V)	7 Amp Quick Blow 1 ¼"
Fuse rating (230V)	5 Amp Quick Blow 1 ¼"
Mains cord and moulded IEC plug and lead set cable (UK) 13A BS1362	3 core earthed / ground. 2 meters long Moulded IEC plug and Lead set – supply cord H05 V V-F- Replace only with equivalent cable.
Mains cord and moulded IEC plug and lead set cable (Europe)	3 core earthed / ground. 2 meters long Moulded IEC plug and Lead set – supply cord H05 V V-F- Replace only with equivalent cable.
Mains cord and moulded IEC plug and lead set cable (USA)	3 core earthed / ground. 2 meters long Moulded IEC plug and Lead set – supply cord SJT VW 1- Replace only with equivalent cable.
Lead set plug fuse (UK – only)	13A
OMCA250 (230V)	5Amp – 200 Watts
OMCA0250x1 (115V)	7Amp – 200 Watts
OMCA0500 (230V)	5Amp – 200 Watts
OMCA0500x1 (115V)	7Amp – 200 Watts
OMCA1000 (230V)	5 Amp – 300 Watts
OMCA1000x1 (115V)	7 Amp – 300 Watts
Stir speed, 250, 500 & 1000	Min 100 RPM. Max 2000RPM

**The Ingress Protection rating for the controller has been classified as IPX1.
The Mantle has been classified as IPX0**

8.2. Product configuration details.

230v	115v	Description
OMCA250	OMCA0250X1	Controller with Stirrer & Mantle (250ml size).
OMCA0500	OMCA0500x1	Controller with Sitter & mantle (500ml size).
OMCA1000	OMCA1000x1	Controller with Stirrer & Mantle (1000ml size).

8.3. Dimensions & Weight (unpacked). –Controller.

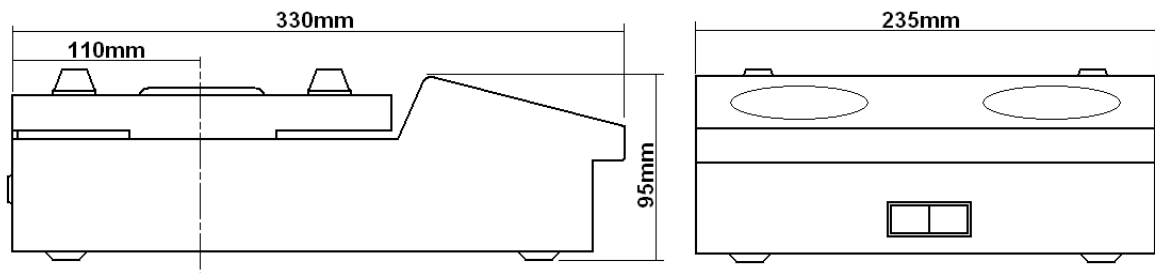

Dimension & Weight (unpacked) – Controller and Mantle.

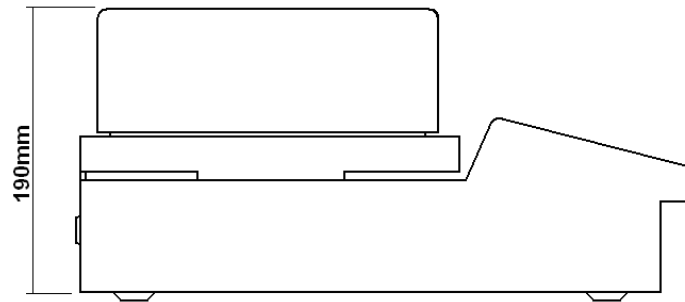

D 330mm. W 235mm. H190mm

Weight 3.1Kg.

9. MAINTENANCE

"DUE TO THE MASS OF THE CARTRIDGE, NEVER SHIP A UNIT WITH THE CARTRIDGE IN PLACE ON THE DIGI-MANTLE. ALWAYS PACK THE CARTRIDGE AND DIGI-MANTLE SEPARATELY BEFORE TRANSPORTATION. "

9.1. General Information.

 Unplug the unit from the mains voltage supply and allow it to cool before undertaking any maintenance tasks.

 Maintenance should only be carried out under the direction of the Responsible Body, by a competent electrician. Failure to do so may result in damage to the product and in extreme cases be a danger to the end user.

With proper care in operation this equipment has been designed to give many years of reliable service. Contamination or general misuse will reduce the effective life of this product and may cause a hazard.

Maintenance for the unit should include:

- Periodic electrical safety testing (an annual test is recommended as the minimum requirement).
- Regular inspection for damage with particular attention to the mains lead and plug set.
- Routine cleaning of the equipment should be undertaken using a clean cloth.

DO NOT USE SOLVENTS FOR CLEANING ANY PART OF THIS EQUIPMENT.

9.2. Fuse Replacement.

The mains fuse holder is located at the rear of the Digi-Mantle. Refer to Technical specification, 'Fuse Rating' for correct fuse type and rating. Turn your Digi-Mantle off and remove it from the mains electricity supply. ① Unscrew both fuse holder caps from the fuse housings and ② remove the fuses. Inspect fuse for damage. Fit replacement fuses of suitable rating and value (See section 8.1 for correct type, rating and value) and refit into fuse housing. See Figure 9-1:

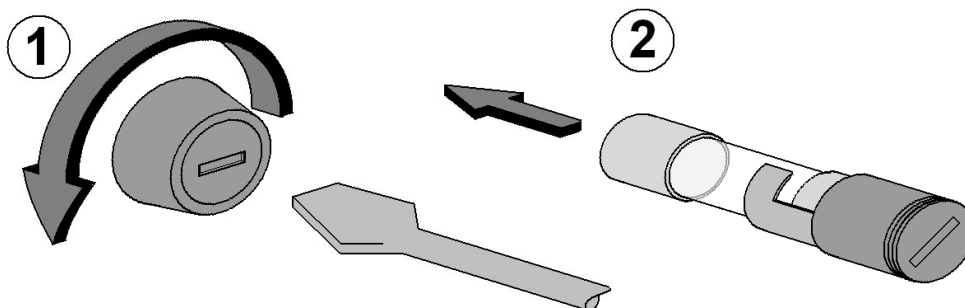

Figure 9 -1

9.3. Spillage and Decontamination.

In the event of spillage switch off and unplug this product from the mains electrical supply. Wipe off all excess liquid from the mantle and surrounding area using an absorbent soft cloth. Do not use the mantle until a drying out period has been allowed and the mantle has been subjected to electrical safety testing by competent service personal. To aid the drying out process, the mantle may be placed in a vented oven at a maximum temperature of 50°C. The drying out period will be dependant on the nature and volume of spillage.



Before further use, the mantle must be subjected to electrical safety testing by competent service personnel.

If in doubt please consult Customer Support. Refer to section 11.



If the equipment has been exposed to contamination, the Responsible Body is responsible for carrying out appropriate decontamination. If hazardous material has been spilt on or inside the equipment, decontamination should only be undertaken under the control of the Responsible Body with due recognition of possible hazards. Before using any cleaning or decontamination method, the Responsible Body should check with the manufacturer the proposed method will not damage the equipment.

Prior to further use, the Responsible Body shall check the electrical safety of the unit. Only if all safety requirements are met can the unit be used again. The above procedure is intended as a guide. Should spillage occur with a toxic or hazardous fluid then special precautions may be necessary.

Decontamination Certificate.

Note: In the event of this equipment or any part of the unit becoming damaged, or requiring service, the item(s) should be returned to the manufacturer for repair accompanied by a decontamination certificate. **Copies of the Certificate are available from Distributor/Manufacturer. Appendix A of this instructions book may be copied and enlarged.**

At the end of life, this product must be accompanied by a Decontamination Certificate. See section 6.3 and 6.4

10.PARTS & ACCESSORIES.

10.1. Spares.

Order additional system items as follows:

Cat No 230V	Cat No 115V	Cat No 100V	Description.
OM0250	OM0250x1	OM0250x3	250ml size mantle. (200W)
OM0500	OM0500x1	OM0500x3	500ml size mantle. (200W)
OM1000	OM1000x1	OM1000x3	1000ml mantle. (300W)
AZ9007	-	-	Fuse 5A 20 x 5mm Glass Quick-blow (Pack 10) (230V)
-	AZ9035	AZ9035	Fuse 8A 20 x 5mm Glass Quick-blow (Pack 10) (115V)
AZ9165	-	-	Mains cord and moulded IEC plug and lead set (UK) 230V ~ AC
AZ6747	-	-	Mains cord and moulded IEC plug and lead set (Europe) 230V ~ AC
-	AZ6746	AZ6746	Mains cord and moulded IEC plug and lead set (USA) 115V ~ AC.
ATS10063	ATS10063	ATS10063	Temperature probe.

11. CUSTOMER SUPPORT.

For help and support in using this product, please contact Customer Services at the following address.

Bibby Scientific Limited.

Beacon Road,
Stone,
Staffordshire ST15 0SA,
Great Britain.

Tel: +44(0)1785 812121
Fax: +44(0)1785 810405

For the America's and Canada, contact:

Techne Incorporated, 3 Terri Lane,
Suite 10 Burlington, NJ 08016 USA.

Toll free:800-225-9243Tel: 609-589-2560

Fax: 609-589-2571

Email: labproducts@techneusa.com

Http www.techneusa.com

- General enquiries :
info@bibby-scientific.com
- Order enquiries :
sales@bibby-scientific.com
- Technical support :
electrothermalhelp@bibby-scientific.com
- www.electrothermal.com

APPENDIX 'A'. DECONTAMINATION CERTIFICATE.

Bibby Scientific Limited. Beacon Road, Stone, Staffordshire ST15 0SA. Great Britain Tel: +44(0)1785 812121. Fax: +44(0)1785 810405 E-mail: electrothermalhelp@bibby-scientific.com		
<u>DECONTAMINATION CLEARANCE CERTIFICATE</u> For the Inspection, Repair or Return of Medical, Laboratory or Industrial Equipment.		
Prior to a Service Engineer working on equipment that has been in an environment where substances hazardous to health may have been used, you are requested to provide the following information:		
CUSTOMER DETAILS		
Company:-	Address:-	
Department:-		
Contact Name:-		
Tel No:-		
Fax No:-	Post Code:-	
Model No:-	<u>Product Description</u>	Serial No:-
Has the equipment been exposed to any of the following, Please answer all questions by deleting YES/NO as applicable and by providing details in section 2 below.		
A. Blood, body fluids, Pathological specimens	YES/NO	Provide details if YES
B. Biodegradable material that could become a hazard	YES/NO	Provide details if YES
C. Other biohazard	YES/NO	Provide details if YES
D. Chemical or substances hazardous to health	YES/NO	Provide details if YES
E. Radioactive substances State name(s) and quantities of isotopes and checks made for residual activity	YES/NO	Provide details if YES
F. Other hazards	YES/NO	Provide details if YES
2. Please provide details of any hazard present as indicated above. Include details of names and quantities of agents as appropriate:-		
3. Your method of decontamination (please describe):-		
4. Are there likely to be any areas of residual contamination (please specify)		
I declare that the above information is true and complete to the best of my knowledge and belief.		
Authorised signature:-	Name (please print):-	
Title/Position:-		
For and behalf of:-	Date:-	

12. EC DECLARATION OF CONFORMITY.

CE marked products and associated accessories covered by this Instruction book conform to the essential requirements of the following directives:

EMC Directive.
Low Voltage Directive.

A full copy of the EC Declaration / Conformity document can be obtained from the manufacture at the email address : info@bibby-scientific.com



Bibby Scientific Limited.

Beacon Road,
Stone,
Staffordshire ST15 0SA,
Great Britain.

Tel: +44(0)1785 812121
Fax: +44(0)1785 810405

- General enquiries :
info@bibby-scientific.com
- Order enquiries :
sales@bibby-scientific.com
- Technical support :
electrothermalhelp@bibby-scientific.com
- www.electrothermal.com

For the America's and Canada, contact:

Techne Incorporated, 3 Terri Lane,
Suite 10 Burlington, NJ 08016 USA.

Toll free:800-225-9243Tel: 609-589-2560
Fax: 609-589-2571
Email: labproducts@techneusa.com
Http www.techneusa.com

Part of the Bibby Scientific Group

